



AutoDome Power Supply Boxes

VG4-A-PSU0 | VG4-A-PSU1 | VG4-A-PSU2



BOSCH

en Installation Guide

Table of Contents

1	Important Safety Instructions	5
1.1	Safety precautions	5
1.2	Important safety instructions	6
1.3	Important Notices	8
1.4	UL certification	10
1.5	Bosch notices	10
2	Installing the Power Supply Box	12
2.1	Unpacking	12
2.1.1	Parts List	12
2.1.2	Optional Parts List	12
2.1.3	Description	13
2.1.4	Tools Required	13
2.2	Pre-installation Check List	13
2.3	Mount the Power Supply Box	15
2.3.1	Attach Cover Door	16
2.4	Route Wires and Attach Connectors	18
2.4.1	Methods for Routing Wires	18
2.4.2	Wiring the Power Supply Box	21
2.4.3	Power Supply Box Connections	22

3	Cable and Wire Standards	24
3.1	Power	24
3.2	Wire Distance Guide	24
3.3	Video and Control Cables	25
3.3.1	Using Coaxial Cable to Transmit Video and Control	25
3.3.2	Using UTP to Transmit Video and Control	26
3.3.3	Using Ethernet to Transmit Video and Control	27
3.3.4	Using Multi-mode Fiber Optic to Transmit Video and Control	27
3.3.5	Using a Fiber Optic Ethernet Media Converter to Transmit Video and Control	28
3.4	Control-only Cables	29
3.4.1	Controlling the AutoDome via Biphas	29
3.4.2	Controlling the AutoDome via the RS232 Protocol	30
3.4.3	Controlling the AutoDome via the RS485 Protocol	32
3.5	Fiber Optic Module with an RS232/RS422 Controller	34
3.5.1	Connecting to an LTC 4629 Head End Data/Video Transceiver	34
3.5.2	Configuring the VG5 AutoDome	34
3.6	Audio Cables	36

1 Important Safety Instructions

Read, follow, and retain all of the following safety instructions. Heed all warnings on the unit and in the operating instructions before operation.

1.1 Safety precautions

DANGER!



High risk: This symbol indicates an imminently hazardous situation such as “Dangerous Voltage” inside the product. If not avoided, this will result in an electrical shock, serious bodily injury, or death.

WARNING!



Medium risk: Indicates a potentially hazardous situation. If not avoided, this could result in minor or moderate bodily injury.

CAUTION!



Low risk: Indicates a potentially hazardous situation. If not avoided, this could result in property damage or risk of damage to the unit.

NOTICE!



This symbol indicates information or a company policy that relates directly or indirectly to the safety of personnel or protection of property.

1.2 Important safety instructions

Read, follow, and retain for future reference all of the following safety instructions. Heed all warnings on the unit and in the operating instructions before operating the unit.

1. **Cleaning** - Unplug the unit from the outlet before cleaning. Follow any instructions provided with the unit. Generally, using a dry cloth for cleaning is sufficient but a moist, fluff-free cloth or leather shammy may also be used. Do not use liquid cleaners or aerosol cleaners.
2. **Water** - Do not use this unit near water, for example near a bathtub, washbowl, sink, laundry basket, in a damp or wet basement, near a swimming pool, in an outdoor installation, or in any area classified as a wet location. To reduce the risk of fire or electrical shock, do not expose this unit to rain or moisture.
3. **Object and liquid entry** - Never push objects of any kind into this unit through openings as they may touch dangerous voltage points or short-out parts that could result in a fire or electrical shock. Never spill liquid of any kind on the unit. Do not place objects filled with liquids, such as vases or cups, on the unit.
4. **Power cord and plug protection** - Protect the plug and power cord from foot traffic, being pinched by items placed upon or against them at electrical outlets, and its exit from the unit. For units intended to operate with 230 VAC, 50 Hz, the input and output power cord must comply with the latest versions of *IEC Publication 227* or *IEC Publication 245*.
5. **Power disconnect** - Units have power supplied to the unit whenever the power cord is inserted into the power source. The power cord plug is the main power disconnect device for switching off the voltage for all units.

6. **Power sources** - Operate the unit only from the type of power source indicated on the label. Before proceeding, be sure to disconnect the power from the cable to be installed into the unit.
 - For battery powered units, refer to the operating instructions.
 - For external power supplied units, use only the recommended or approved power supplies.
 - For limited power source units, this power source must comply with *EN60950*. Substitutions may damage the unit or cause fire or shock.
 - For 24 VAC units, voltage applied to the unit's power input should not exceed $\pm 10\%$, or 28 VAC. User-supplied wiring must comply with local electrical codes (Class 2 power levels). Do not ground the supply at the terminals or at the unit's power supply terminals.
 - If unsure of the type of power supply to use, contact your dealer or local power company.
7. **Servicing** - Do not attempt to service this unit yourself. Opening or removing covers may expose you to dangerous voltage or other hazards. Refer all servicing to qualified service personnel.
8. **Damage requiring service** - Unplug the unit from the main AC power source and refer servicing to qualified service personnel when any damage to the equipment has occurred, such as:
 - the power supply cord or plug is damaged;
 - exposure to moisture, water, and/or inclement weather (rain, snow, etc.);
 - liquid has been spilled in or on the equipment;
 - an object has fallen into the unit;
 - unit has been dropped or the unit cabinet is damaged;
 - unit exhibits a distinct change in performance;
 - unit does not operate normally when the user correctly follows the operating instructions.

9. **Replacement parts** - Be sure the service technician uses replacement parts specified by the manufacturer, or that have the same characteristics as the original parts. Unauthorized substitutions may cause fire, electrical shock, or other hazards.
10. **Safety check** - Safety checks should be performed upon completion of service or repairs to the unit to ensure proper operating condition.
11. **Installation** - Install in accordance with the manufacturer's instructions and in accordance with applicable local codes.
12. **Attachments, changes or modifications** - Only use attachments/accessories specified by the manufacturer. Any change or modification of the equipment, not expressly approved by Bosch, could void the warranty or, in the case of an authorization agreement, authority to operate the equipment.

1.3 Important Notices

U.S.A. models only - *Section 810 of the National Electrical Code, ANSI/NFPA No. 70*, provides information regarding proper grounding of the mount and supporting structure, grounding of the coax to a discharge unit, size of grounding conductors, location of discharge unit, connection to grounding electrodes, and requirements for the grounding electrode.



Disposal - Your Bosch product was developed and manufactured with high-quality material and components that can be recycled and reused. This symbol means that electronic and electrical appliances, which have reached the end of their working life, must be collected and disposed of separately from household waste material. Separate collecting systems are usually in place for disused electronic and electrical products. Please dispose of these units at an environmentally compatible recycling facility, per *European Directive 2002/96/EC*

Environmental statement - Bosch has a strong commitment towards the environment. This unit has been designed to respect the environment as much as possible.

Power lines: An outdoor system should not be located in the vicinity of overhead power lines, electrical lights, or power circuits, or where it may contact such power lines or circuits. When installing an outdoor system, extreme care should be taken to keep from touching power lines or circuits, as this contact may be fatal.

U.S.A. models only - refer to the National Electrical Code *Article 820* regarding installation of CATV systems.

SELV - All the input/output ports are Safety Extra Low Voltage (SELV) circuits. SELV circuits should only be connected to other SELV circuits.

Because the ISDN circuits are treated like telephone-network voltage, avoid connecting the SELV circuit to the Telephone Network Voltage (TNV) circuits.

System ground/Safety ground

System (video) ground is indicated by the symbol .

Safety (power) ground is indicated by the symbol .

The system ground is only used to comply with safety standards or installation practices in certain countries. Bosch does **not** recommend connecting system ground to safety ground unless it is explicitly required. However, if the system ground and safety ground are connected and grounding loops are causing interference in the video signal, use an isolation transformer (available separately from Bosch).



CAUTION!

Connecting System ground to Safety ground may result in ground loops that can disrupt the CCTV system.

1.4 UL certification

Disclaimer

Underwriter Laboratories Inc. (“UL”) has not tested the performance or reliability of the security or signaling aspects of this product. UL has only tested fire, shock and/or casualty hazards as outlined in UL's *Standard(s) for Safety for Closed Circuit Television Equipment, UL 2044*. UL Certification does not cover the performance or reliability of the security or signaling aspects of this product.

UL MAKES NO REPRESENTATIONS, WARRANTIES, OR CERTIFICATIONS WHATSOEVER REGARDING THE PERFORMANCE OR RELIABILITY OF ANY SECURITY OR SIGNALING RELATED FUNCTIONS OF THIS PRODUCT.

Disclaimer

Underwriter Laboratories Inc. (“UL”) has not tested the performance or reliability of the security or signaling aspects of this product. UL has only tested fire, shock and/or casualty hazards as outlined in UL's *Standard(s) for Safety for Information Technology Equipment, UL 60950-1*. UL Certification does not cover the performance or reliability of the security or signaling aspects of this product.

UL MAKES NO REPRESENTATIONS, WARRANTIES, OR CERTIFICATIONS WHATSOEVER REGARDING THE PERFORMANCE OR RELIABILITY OF ANY SECURITY OR SIGNALING-RELATED FUNCTIONS OF THIS PRODUCT.

1.5 Bosch notices

Video loss

Video loss is inherent to digital video recording; therefore, Bosch Security Systems cannot be held liable for any damage that results from missing video information. To minimize the risk of lost digital information, Bosch Security Systems recommends multiple, redundant recording systems, and a procedure to back up all analog and digital information.

Copyright

This manual is the intellectual property of Bosch Security Systems and is protected by copyright. All rights reserved.

Trademarks

All hardware and software product names used in this document are likely to be registered trademarks and must be treated accordingly.

Note:

This manual has been compiled with great care and the information it contains has been thoroughly verified. The text was complete and correct at the time of printing. The ongoing development of the products may mean that the content of the user guide can change without notice. Bosch Security Systems accepts no liability for damage resulting directly or indirectly from faults, incompleteness or discrepancies between the user guide and the product described.

More information

For more information please contact the nearest Bosch Security Systems location or visit www.boschsecurity.com

2 Installing the Power Supply Box

2.1 Unpacking

This equipment should be unpacked and handled with care. If an item appears to have been damaged in shipment, notify the shipper immediately.

Verify that all the parts listed in the product's Parts List below are included. If any items are missing, notify your Bosch Security Systems Sales or Customer Service Representative. The original packing carton is the safest container in which to transport the unit and must be used if returning the unit for service. Save it for possible future use.

2.1.1 Parts List

The following table lists the parts included with one of the following power supply boxes:

Power Supply Box	Part Number
24 VAC (no transformer) power supply, NEMA-rated with cover	VG4-A-PSU0
120 VAC transformer power supply, NEMA-rated with cover	VG4-A-PSU1
230 VAC transformer power supply, NEMA-rated with cover	VG4-A-PSU2

2.1.2 Optional Parts List

The following table lists the optional equipment for use with the power supply boxes:

Option	Part Number
Trim skirt	VGA-A-TSKIRT
Replacement power supply box cover	VG4-SBOX-COVER
Analog Multimode Fiber Optic Kit	VGA-FIBER-AN
Ethernet Media Converter Kit	VG4-SFPSCKT

Note: The fiber optic kits are mounted inside the power supply box. Refer to the individual kit for installation instructions.

2.1.3 Description

This chapter details how to install an AutoDome power supply box. Any variations to the installation procedures are noted. These power supply boxes are intended for use with the VGA-PEND_ARM Arm Mount, VGA-A-9543 Pipe Mount, and the VG4-A-9230 or VGA-ROOF-MOUNT Roof Parapet Mount. For complete AutoDome installation, mounting, and wiring information, refer to the *VG5 Series AutoDome Installation Manual* that was included with the AutoDome pendant packaging.

2.1.4 Tools Required

- Small straight blade screwdrivers ~ 2.5 mm (0.1 in.) – 3.1 mm (1/8 in.)
- Medium straight blade screwdriver
- No. 1 and No. 2 Phillips screwdrivers
- Socket wrench and 9/16 in. socket
- Power drill
- Water tight conduits and fittings that meet NEMA 4 standards

2.2 Pre-installation Check List

1. Determine the location and distance for the power supply box based on its voltage and current consumption. Refer to *Section 3 Cable and Wire Standards, page 24* for wiring information and distances.
2. Use only UL listed liquid-tight strain reliefs for conduits to the power supply box to ensure that water cannot enter the box. You must use water tight conduits and fittings to meet NEMA 4 standards.



NOTICE!

Power and I/O cabling must be routed separately inside different permanently earthed metal conduits.

3. Install all rough wiring including: power, control, video coax, alarms I/O, relay I/O, and fiber optic cabling. Refer to *Section 3 Cable and Wire Standards, page 24* for video and control protocol methods.
4. **Analog AutoDome:** If you plan to use the RS232 or RS485 protocol to control the AutoDome, refer to *Section 3.4.2 Controlling the AutoDome via the RS232 Protocol, page 30*, or *Section 3.4.3 Controlling the AutoDome via the RS485 Protocol, page 32*, for instructions on configuring the AutoDome to accept these protocols.

WARNING!

External interconnecting cables are to be installed in accordance to NEC, ANSI/NFPA70 (for US application) and Canadian Electrical Code, Part I, CSA C22.1 (for CAN application) and in accordance to local country codes for all other countries.



Branch circuit protection incorporating a 20 A, 2-pole Listed Circuit Breaker or Branch Rated Fuses are required as part of the building installation. A readily accessible 2-pole disconnect device with a contact separation of at least 3 mm must be incorporated.

-
5. Purchase the appropriate mounting hardware to use, depending on the location of power supply box.

2.3 Mount the Power Supply Box

Before mounting the power supply box decide if you will be wiring the box through the holes in the bottom or back of the box. If wiring the box through the back, move the two (2) seal plugs to the bottom holes before mounting.

**NOTICE!**

Use 3/4-inch NPS (20-mm) fittings for the holes on the bottom and back of the box. Use 1/2-inch NPS (15-mm) fittings for the side holes.

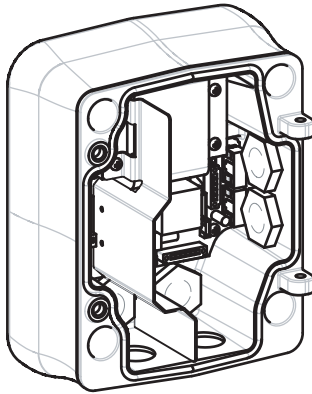

Figure 2.1 Power Supply Box with Optional Trim Skirt

1. Use the wall mount template supplied in the packaging box to locate the four (4) mounting holes for the power supply box.
2. Drill four (4) holes for the mounting anchors. If installing outdoors, apply a weatherproof sealant around each hole at the mounting surface.
3. Place the power supply box into the optional trim skirt.
4. Secure the power supply box to the wall using four (4) corrosion-resistant stainless steel studs (not included).

**NOTICE!**

A stud diameter of 6.4 mm (1/4 in.) or 8 mm (5/16 in.), able to withstand a 120 kg (265 lb) pull-out force is recommended.

- Attach the 3/4 in. (20 mm) watertight pipe fittings (not supplied) to the holes of the power supply box through which you will run the power, video, and control data wires.

2.3.1 Attach Cover Door

- Compress the bottom hinge pin by pushing the pin lever down and then rotate it behind the hinge pin stop. The power box cover door provides a hinge pin stop to hold the bottom hinge open while attaching the door.

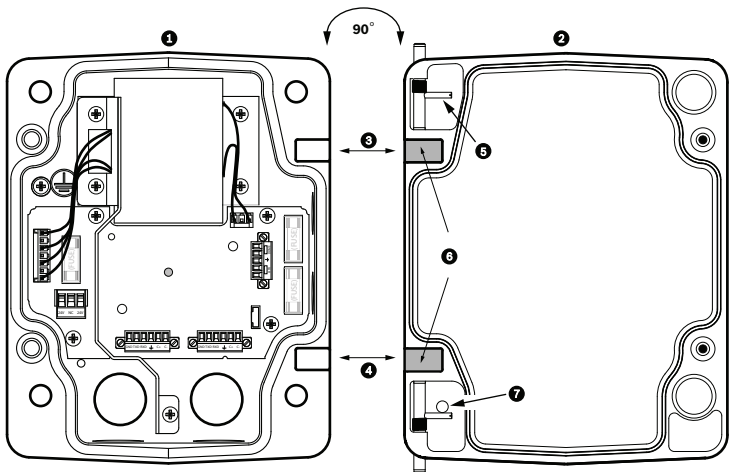

Figure 2.2 Align Cover Door Hinge to Power Box

1	Power Supply Box	5	Hold Hinge Pin Open
2	Cover Door	6	Open Position
3	Align Top Hinge	7	Hinge Pin Stop
4	Align Bottom Hinge		

- Open the top hinge by pushing its pin lever outward and holding it open.

Note: Both hinge pins must be fully compressed to open (unlock) the female hinges of the cover door before proceeding to the next step.

3. While holding the top hinge pin open, position the cover door to the power supply box and align its hinges.
4. When the hinges are aligned, release the top hinge pin to engage its mating hinge on the power box. Then release the bottom hinge pin from the hinge pin stop to complete attaching the cover door to the power supply box.

**NOTICE!**

After all wiring is complete, close the cover door and tighten the two (2) captive screws on the cover door to 10-12 N-m (90-105 in.-lbs) to ensure the power supply box is watertight.

2.4 Route Wires and Attach Connectors

Power wires must be routed to the left (front) side of the power supply box through a separate conduit. All video, control, and alarm wires must be routed through a second conduit to the right side of the box. Refer to *Section 3 Cable and Wire Standards, page 24* for methods of transmitting video and data, and for wire specifications.

WARNING!



External interconnecting cables are to be installed in accordance to NEC, ANSI/NFPA70 (for US application) and Canadian Electrical Code, Part I, CSA C22.1 (for CAN application) and in accordance to local country codes for all other countries.

Branch circuit protection incorporating a 20 A, 2-pole Listed Circuit Breaker or Branch Rated Fuses are required as part of the building installation. A readily accessible 2-pole disconnect device with a contact separation of at least 3 mm must be incorporated.

2.4.1 Methods for Routing Wires

There are two possible methods to route the video, control, and alarm wires:

- One is to route the video, control, and alarm wires through the conduit fitting on the right (front) side of the power supply box and out to the AutoDome Arm Mount or to the Interface Board (for Pipe and Roof Parapet mounts).

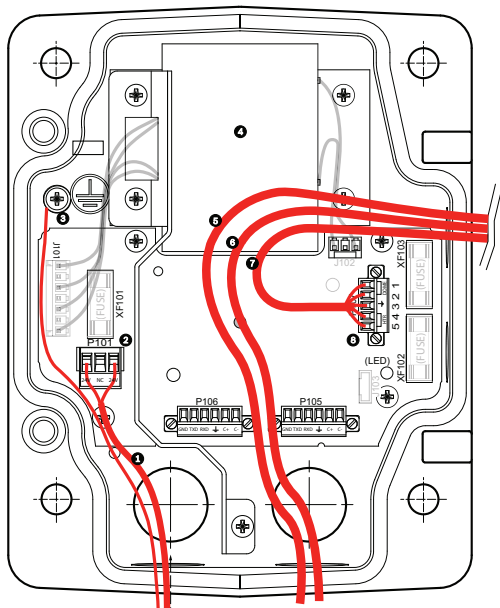

Figure 2.3 VG4-A-PSU1 or VG4-A-PSU2 Power Supply Box

1	24/120/230 VAC Power In	5	Coax, UTP Video, or Ethernet Wire (Ethernet for VG5 700 Series only)
2	P101 Connector	6	Control Wire
3	Ground Connection	7	24 VAC Power Out
4	Transformer	8	P107 Connector

- The second method is to bypass the power supply box and route the video, control, and alarm wires directly to the AutoDome Arm Mount, Pipe Mount, or to the Roof Parapet Mount. You connect only the power wires inside the power supply box.

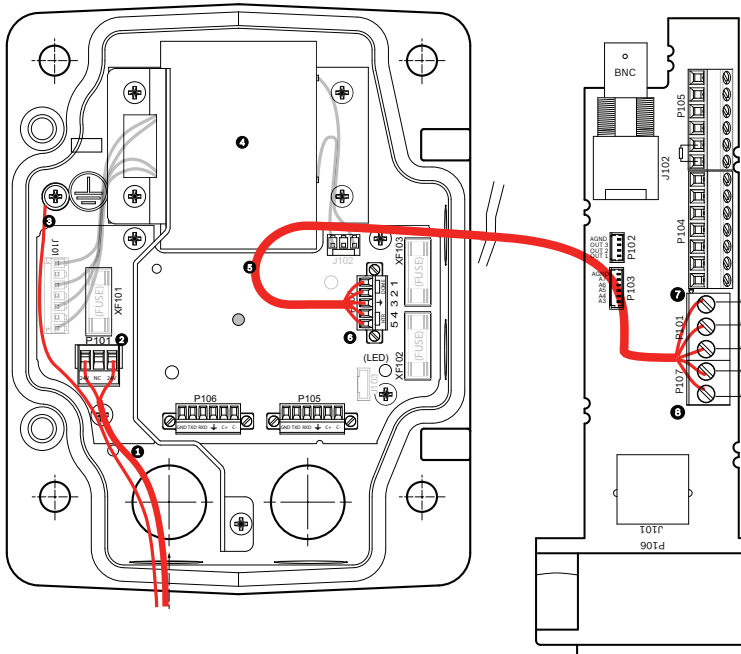

Figure 2.4 VG4-A-PSU1 or VG4-A-PSU2 Power Supply Box Connected to Pipe Interface Board

	VG4-A-PSU1/PSU2		Pipe Interface Board
1	24/12/230 VAC Power In	7	P101 Connector
2	P101 Connector	8	P107 Connector
3	Ground Connection	9	24 VAC Power In (to AutoDome)
4	Transformer	10	Earth Ground
5	24 VAC Power Out	11	24 VAC Power In (to AutoDome)
6	P107 Connector	12	24 VAC Power In (to Heater)
		13	24 VAC Power In (to Heater)
		14	AutoDome Power
		15	Heater Power

2.4.2 Wiring the Power Supply Box

1. Route the high voltage 115/230 VAC lines through the conduit fitting on the left side of the box.
or
Route the 24 VAC lines through the conduit fitting on the left side of the box.



NOTICE!

The power supply box with transformer comes with a barrier that separates the high voltage side on the left from the low voltage 24 VAC side on the right.

2. Cut and trim the high voltage 24/115/230 VAC power and ground wires with sufficient slack to reach their connector terminal in the box, but not so long as to be pinched by or to obstruct closing the cover door.
3. Attach the supplied 3-pin power plug to the incoming high voltage power wires in the box. Refer to connector P101 in *Table 2.1, Page 23*.
4. **Analog AutoDome:** If you are using UTP for video, route the UTP cable out to where the AutoDome will be mounted. Refer to *Section 3 Cable and Wire Standards, page 24* for fiber optic specifications.
5. **IP AutoDome:** Route the Ethernet cable out to where the AutoDome will be mounted. Refer to *Section 3 Cable and Wire Standards, page 24* for specifications.
6. Route the low power 24 VAC wires from the right side of the power supply box out to where the AutoDome will be mounted. Attach the supplied 5-pin 24 VAC Dome plug to the wire ends inside the box. Refer to connector P107 in *Table 2.1, Page 23*.



NOTICE!

All video, control, and alarm wires either pass through the power supply box or by-pass it and connect directly to the Pipe Interface Board.

2.4.3 Power Supply Box Connections

The following figure is a detailed illustration of the power supply box, which includes the fuse specifications.

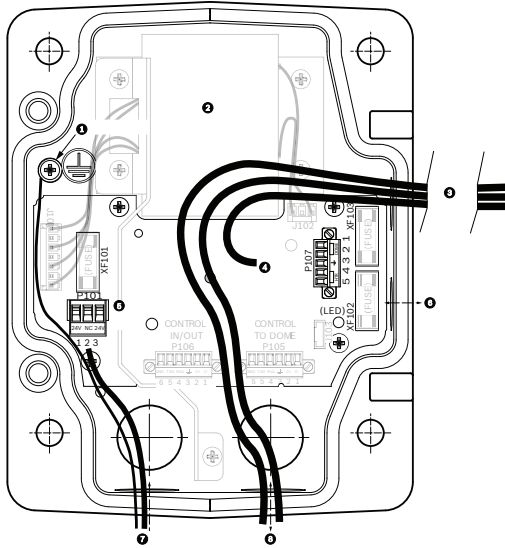

1	Ground Screw	5	Power In
2	Transformer (115/230 VAC Modes)	6	In/Out; 1/2 in. (15 mm) NPS Fitting
3	In/Out to Dome	7	Power In; 3/4 in. (20 mm) NPS Fitting
4	24 VAC to Dome Interface Board	8	Control Data and Video In/Out; 3/4 in. (20 mm) NPS Fitting



WARNING!

Fuse replacement by qualified service personnel only. Replace with same type fuse.

Fuse Specifications			
Volts	XF101 Mains	XF102 Camera	XF103 Heater
24 V	T 5.0 A	T 2.0 A	T 3.15 A
115 V	T 1.6 A	T 2.0 A	T 3.15 A
230 V	T 0.8A	T 2.0 A	T 3.15 A

The following table lists the Power Supply Box connectors:

No.	Connector	Pin 1	Pin 2	Pin 3	Pin 4	Pin 5	Pin 6
	Ground	Grounding Screw					
P101	115/230 VAC or 24 VAC Power In	Line	NC	Neutral			
P105 ¹	Control to Dome (Fiber Optic Model)	C- (Biphase)	C+ (Biphase)	Earth Ground	RXD (+) (RS-232/485)	TXD (-) (RS-232/485)	Signal Ground
P106 ¹	Control In/Out (Optional)	C- (Biphase)	C+ (Biphase)	Earth Ground	RXD (+) (RS-232/485)	TXD (-) (RS-232/485)	Signal Ground
P107	24 VAC Power to Dome Plug	Dome 24 VAC	Dome 24 VAC	Earth Ground	Heater (24 VAC)	Heater (24 VAC)	
1. Applicable to VG5 100 and 600 Series AutoDomes only.							

Table 2.1 Power Box Connections

3 Cable and Wire Standards



CAUTION!

Installation should only be performed by qualified service personnel in accordance with the National Electrical Code or applicable local codes.



CAUTION!

All wires for installation applications must be routed through a grounded conduit.

3.1 Power

24/115/230 VAC	
Copper Wire	To comply with local codes.

3.2 Wire Distance Guide

24 V to AutoDome				
	VA / Watts	14 AWG (2.5 mm)	16 AWG (1.5 mm)	18 AWG (1.0 mm)
AutoDome 100, Indoor	14 / 7.5	248 m (813 ft)	156 m (512 ft)	98 m (322 ft)
AutoDome 100, Outdoor	47 / 43.5	74 m (242 ft)	46 m (152 ft)	29 m (96 ft)
AutoDome 600, Indoor	27 / 15	129 m (422 ft)	81 m (265 ft)	51 m (167 ft)
AutoDome 600, Outdoor ¹	55 / 51	63 m (207 ft)	40 m (130 ft)	25 m (82 ft)
AutoDome 700, Indoor	35 / 19	99 m (325 ft)	62 m (205 ft)	39 m (129 ft)
AutoDome 700, Outdoor ²	60 / 55	58 m (190 ft)	36 m (119 ft)	23 m (75 ft)
1. Standard heater module. Add Add 16 W if using VG4-SHTR-XT kit. 2. Standard heater module. The VG4-SHTR-XT kit is not applicable to VG5 700 Series AutoDomes.				

3.3 Video and Control Cables

3.3.1 Using Coaxial Cable to Transmit Video and Control

CAUTION!



600 Series AutoDome: If you are using coaxial cable to transmit video and data between the AutoDome and the head-end, you must use the coax cable with ferrite included in the AutoDome packaging. You must connect the incoming coax cable (from the head-end) to the jack (female end) on the ferrite cable and connect the plug end (male connector) of the ferrite cable to the AutoDome's coax connector.

Coaxial cable terminated with BNC connectors is the most common method for transmitting composite video. Bilinx control data can also be sent over the same cable.

Bilinx is a Bosch 2-way communication protocol that allows remote control, configuration, and updates over a video coax cable. Bilinx is available on all VG5 100 and 600 Series AutoDomes.

VG5 Series AutoDomes feature cable compensation or “Pre-Comp,” which extends the range of video from the head end.

Cable Compensation	Maximum Distances		
	Video Only		Bilinx Control
Cable Type	Pre-comp OFF	Pre-comp ON	Pre-comp ON or OFF
RG-59/U	300 m (1000 ft)	600 m (2000 ft)	300 m (1000 ft)
RG-6/U	450 m (1500 ft)	900 m (3000 ft)	450 m (1500 ft)
RG-11/U	600 m (2000 ft)	1200 m (4000 ft)	600 m (2000 ft)
Size	O.D. between 4.6 mm (0.181 in.) and 7.9 mm (0.312 in.)		
Shield	Copper braid: 95%		
Central Conductor	Standard copper center		
Terminal Connector	BNC		



WARNING!

Cable compensation (Pre-Comp) does not extend the range of Bilinx control. Pre-Comp is not available with VG5 700 Series AutoDomes.

3.3.2 Using UTP to Transmit Video and Control

Unshielded twisted pair (UTP) cable terminated with RJ45 male connectors are used to transmit composite video using pins 1(+) and 2(-). Typically, a Coax to UTP cable converter is required at the head-end of the system.

Bilinx control data can also be sent over the same two video wires (1 & 2). Bilinx is a Bosch 2-way communication protocol that allows remote control, configuration and updates over a passive UTP cable.

VG5 100 and 600 Series AutoDomes feature cable compensation or “Pre-Comp,” which extends the normal range of control from the head end.



WARNING!

Do not connect the RJ45 connector unless using UTP video.

Cable Compensation	Maximum Distance	
	Pre-comp OFF	Pre-comp ON
Cable Type	229 m (750 ft)	450 m (1500 ft)
Terminal Connector	RJ45	
Requirement	Coax to UTP Converter	

The following figure illustrates the connections necessary to transmit video and control over a UTP cable.

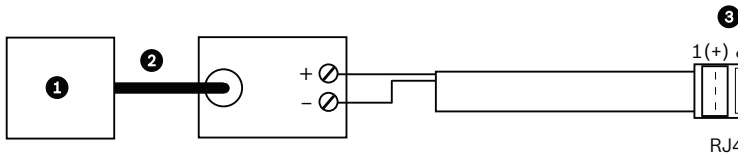

Figure 3.1 Video and Control over UTP

1	Head End Video	3	Pins
2	Coax	4	AutoDome

3.3.3 Using Ethernet to Transmit Video and Control



CAUTION!

Ethernet connections must be made to non-exposed (indoor) networks only.

The AutoDome VG5 700 series connects to a 10 Base-T/100 Base-TX network either directly or via a switch. Both video and control are transmitted over a standard TCP/IP network using the built-in Web server.

Cable Type	CAT-5E or CAT 6 Ethernet
Maximum Distance	100 m (328 ft)
Bandwidth	10 Base-T/100 Base-TX
Terminal Connector	RJ45, Female



WARNING!

Do not connect a coaxial cable while the RJ45 Ethernet cable is connected.

3.3.4 Using Multi-mode Fiber Optic to Transmit Video and Control

Fiber Optic kits, available for AutoDome 100 and 600 Series cameras, transmit both video and Biphase control over an analog singlemode or multimode fiber.

Multimode	
Fiber Type	50/125 μm , 62.5/125 μm , low loss multimode glass fiber
Maximum Distance	4 km (2.5 miles)
Minimum Bandwidth	20 MHz (Video - 850 nm / Control - 1300 nm)
Requirement	Bosch LTC 4629 Fiber Receiver at controller end of system
Terminal Connector	ST

Singlemode	
Fiber Type	9/125 μm , low loss single glass fiber
Maximum Distance	69 km (43 miles)
Minimum Bandwidth	20 MHz (Video - 1310 nm /Control - 1550 nm)
Requirement	Single mode fiber receiver at controller end of system
Terminal Connector	ST

3.3.5 Using a Fiber Optic Ethernet Media Converter to Transmit Video and Control

The fiber optic media converter kit, available for AutoDome 700 Series cameras, is designed to transmit 10/100 Mbps Ethernet signals over fiber optic cable using 10/100 Mbps Small Form-factor Pluggable (SFP) modules. The SFP modules are available as multi-mode fiber (MMF) or single-mode fiber (SMF) models with a single SC connector or dual-fiber with an LC connector. Refer to the *VG4-SFPSCKT Fiber Optic Media Converter Installation Guide*.

Ethernet Media Converter	
Data Interface	Ethernet
Data Rate	10/100 Mbps IEEE 802.3 Compliant Full Duplex or Half Duplex Electrical Port Full Duplex Optical Port
Fiber Type, MMF	50/125 μm MMF. For 50/125 μm fiber, subtract 4 dB from the specified optical budget value. Must meet or exceed fiber standard ITU-T G.651.
Fiber Type, SMF	8–10/125 μm SMF. Must meet or exceed fiber standard ITU-T G.652.
Maximum Distance	60 km (37.3 miles)
Requirement	Media converter receiver (CNFE2MC/IN) at controller end of system
Terminal Connection	Duplex LC or Single SC

3.4 Control-only Cables

3.4.1 Controlling the AutoDome via Biphase

(Shielded 2-wire, half-duplex, multi-drop, 5000 ft. cable limit)
Biphase is the standard Bosch protocol used to send Pan/Tilt/Zoom control over 2-wire shielded twisted pair (STP) terminated with a 100 Ω terminal resistor.

The AutoDome has a 100 Ω termination resistor between the Biphase C+ and C- terminals.



CAUTION!

The Biphase shield must be connected to the head end only.

Cable Type	STP - Shielded Twisted Pair
Distance	1524 m (5000 ft) Belden 8760 recommended
Transmission Rate	31.25 KHz
Gage	1.02 mm (18 AWG)
Termination	100 Ω
Terminal Connector	Screw terminals
Voltage	4 Vp-p

The figure below illustrates the connections necessary for Biphase operation.

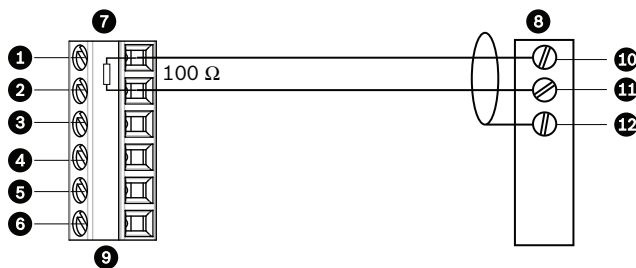

Figure 3.2 Connections for Biphase Operation

1	C- (Biphase)	7	AutoDome Data In/Out
2	C+ (Biphase)	8	Head End Biphase
3	Earth Ground	9	P105/P106 Connector in Power Supply Box
4	RxD	10	C- (Biphase)
5	TxD	11	C+ (Biphase)
6	Signal Ground	12	Shield

In a daisy chain configuration, where multiple domes are connected in series, the 100 Ω resistor must be removed from all but the last dome. You can daisy chain a maximum of four (4) AutoDomes.

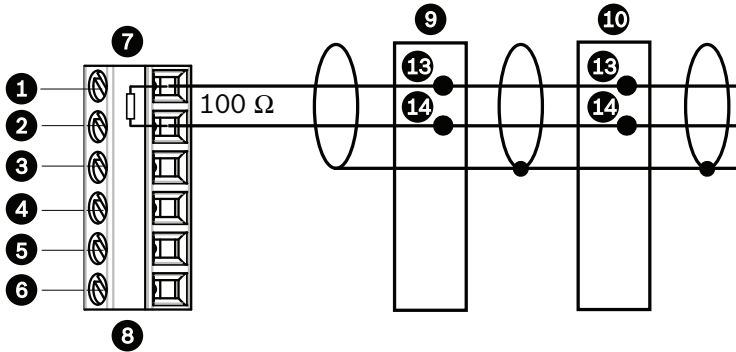

Figure 3.3 Connections for a Daisy Chain Configuration

1	C- (Biphase)	9	Dome 3
2	C+ (Biphase)	10	Dome 2
3	Earth Ground	11	Dome 1
4	RxD	12	Head End Biphase
5	TxD	13	C- (Biphase)
6	Signal Ground	14	C + (Biphase)
7	Last Dome Data In/Out	15	Shield
8	P105/P106 Connector in Power Supply Box		

3.4.2 Controlling the AutoDome via the RS232 Protocol (3-wire, full-duplex, single-ended, 50 ft. cable limit)

RS232 is a common, single-ended communication protocol used for control. Data transmission via 3-wires (TDX, RXD, common) is from one transmitter to one receiver at relatively slow baud rates (up to 57.6 Kbaud) and short distances up to 50 ft.



NOTICE!

After making the wire connections for RS232 operation, reposition the slide switch located on the CPU Module to the camera head inward and away from the LEDs.

Wire Type	3-wire (TXD, RXD, common)
Distance	15 m (50 ft)
Maximum Baud Rate	57.6 Kb
Voltage	± 15 V
Termination	100 Ω
Slide Switch	Away from LEDs (factory default)

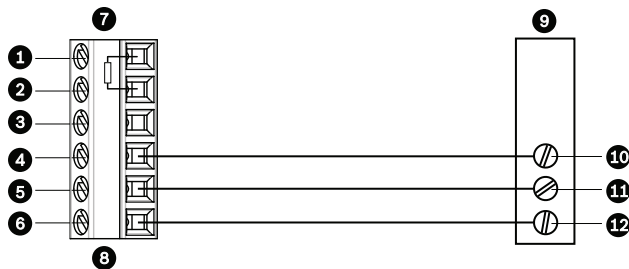

Figure 3.4 Connections for RS232 Operation

1	C- (Biphase)	7	AutoDome Data In/Out
2	C+ (Biphase)	8	P105/P106 Connector in Power Supply Box
3	Earth Ground	9	Head End RS232
4	RxD	10	TxD
5	TxD	11	RxD
6	Signal Ground	12	Ground

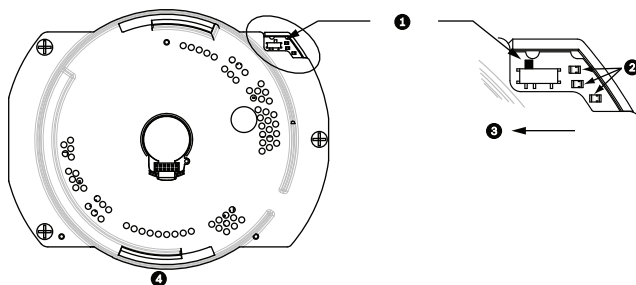

Figure 3.5 Position of CPU Switch for RS232 Operation (camera module not shown for clarity)

1	Switch Location
2	LEDs
3	RS232
4	CPU Module

Note: To access the CPU switch you must remove the bubble from the pendant housing.

3.4.3 Controlling the AutoDome via the RS485 Protocol

2-wire (shielded), half-duplex, differential, multi-drop (32 nodes), 4000 ft cable limit)

RS485 is capable of controlling a true multi-drop network and is specified for up to 32 drivers and 32 receivers on a single 2-wire bus. The AutoDome uses the 2-wire mode, although RS485 can be connected in a 2- or 4-wire mode.

NOTICE!



The wire shield must be tied to signal at both ends, if 2-wire twisted pair is used. After connecting the wires for RS485 operation, make sure the slide switch on the main board to the camera head is positioned toward the LEDs (default).

CAUTION!



Bosch recommends that multiple RS485 connections be arranged as a connected series of point-to-point (multi-dropped) nodes, as a line or as a bus. It is **not** recommended to arrange RS485 connections as a star, ring, or as a multiple-connected network. Star and ring topologies may cause signal reflections or excessively low or high termination impedance.

Wire Type	2-wire shielded twisted pair
Distance	1219 m (4000 ft)
Maximum Baud Rate	57.6 kb
Gage	0.511 mm (24 AWG)
Wire Impedance	120 W
Slide Switch	Toward LEDs (factory default)

The following figure illustrates the connections for RS485 connections.

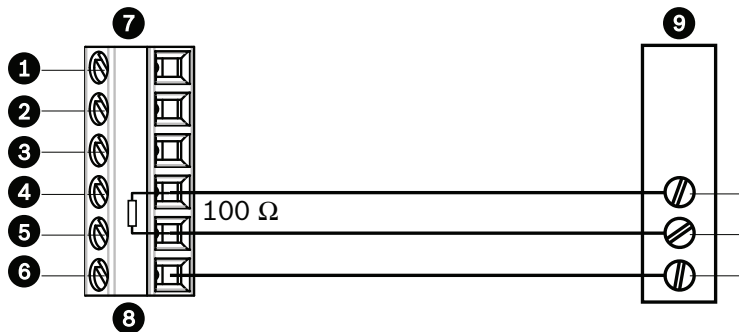

Figure 3.6 Connections for RS485 Operations

1	C- (Biphase)	7	AutoDome Data In/Out
2	C+ (Biphase)	8	P105/P106 Connector in Power Supply Box
3	Earth Ground	9	Head End RS485
4	RxD	10	Data +
5	TxD	11	Data -
6	Signal Ground	12	Ground

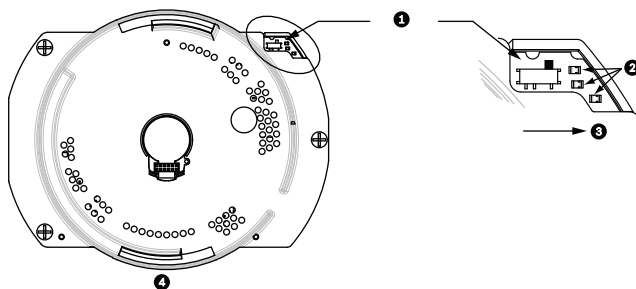

Figure 3.7 Position of CPU Switch for RS485 Operation (camera module not shown for clarity)

1	Switch Location
2	LEDs
3	RS485
4	CPU Module

Note: To access the CPU switch you must remove the bubble from the pendant housing.

3.5 Fiber Optic Module with an RS232/RS422 Controller

An AutoDome with a fiber optic module is prewired to operate with Biphasic signals only. This section describes the procedures necessary to control a VG5 series AutoDome fitted with a fiber optic kit using an RS232 controller or a Pelco® RS422 controller.

To control a VG5 Series AutoDome from an RS232 or from a Pelco RS422 controller you must run control wires from the controller to an LTC 4629 head-end fiber optic module.

3.5.1 Connecting to an LTC 4629 Head End Data/Video Transceiver

1. Connect the RS232 cable (TxD from the controller) to the RS232 RxD port (pin 1) of the LTC 4629.
2. Connect the ground wire of the controller to Pin 2 on the LTC 4629.

3.5.2 Configuring the VG5 AutoDome

1. Disconnect the power to the VG4 power supply unit; then open the unit.
2. Remove the green Serial Communications wire from the P106 connector.
3. Remove the 100 Ω resistor across the C+ and C- pins.
4. Cut the five wires from the green Serial Communications wire mating connector.
Ensure that the insulation covers each wire to avoid wires from touching.
5. Cut back the insulation on the blue (ground) wire and on the green (Rx/D) wire enough to be able to connect these wires back into the P106 connector.
6. Connect the blue (ground) wire to the C- pin on the P106 connector.

7. Connect the green (RxD) wire to the C+ pin on the P106 connector.

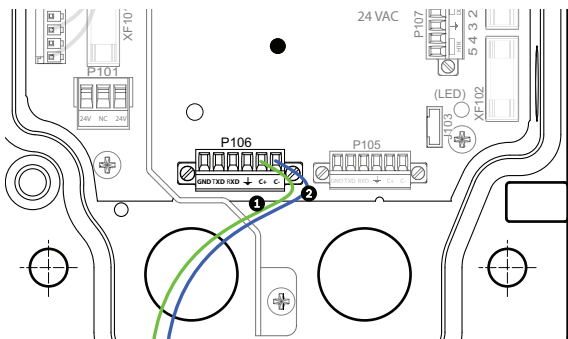

Figure 3.8 Detail of P106 Connections

1	Green RxD wire connected to C+
2	Blue Ground wire connected to C-

8. Connect the fiber optic cable from the AutoDome to the LTC 4629.
9. Close the door to the power supply unit.
10. Ensure that the VG5 AutoDome is set to receive RS232 commands.
 - Remove the bubble from the VG5 AutoDome housing.
 - Locate the protocol switch on the CPU board.
 - Ensure that the protocol switch is in the left position for RS232 operation.

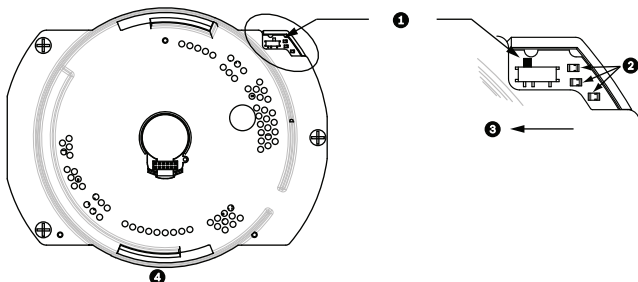

Figure 3.9 Position of CPU Switch for RS232 Operation

1	Switch Location
2	LEDs
3	Move Switch to the left for RS232 Operation
4	CPU Module

11. Return the bubble to the AutoDome housing.
12. Return power to the power supply box.

3.6 Audio Cables

The VG5 700 Series AutoDome is capable of receiving line input audio signals and transmitting it over a network. The audio signal is transmitted one-way and in sync with the video signals.

Audio Line Input Specifications

Max. Input Voltage	5.5 Vpp
Impedance	9K Ω
Sample Rate	8 K Hz, 16 Bit, mono
Shield	Bare copper braid: 95% coverage
Internal gain level adjustment is available	

Wire Specifications

Wire Type	Coax³ (recommended)
Distance	10 m (33 ft)
Gage	22 AWG to Biphase connector (P105/P106)
Shield	Bare copper braid: 95% coverage
Center conductor	Stranded bare copper



NOTICE!

Separate the audio cables from the AC power lines to avoid noise.

Audio Connections

1. Remove the 100 Ω termination resistor from the Biphase terminals.
2. Connect the audio line level source to the Biphase C+ input terminal.
3. Connect the audio signal ground to the Biphase C- input terminal.

The following figure illustrates the connections for audio over an IP network.

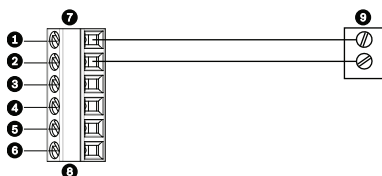

Figure 3.10 Connections for audio over an Ethernet network

1	C- (Biphase)	7	AutoDome Data In/Out
2	C+ (Biphase)	8	P105/P106 Connector
3	Earth Ground	9	Audio Out
4	RxD		
5	TxD		
6	Signal Ground		



NOTICE!

Refer to the *VG5 700 Series AutoDome User Manual* for configuring and using audio over an IP Ethernet network.

Bosch Security Systems, Inc.

850 Greenfield Road

Lancaster, PA 17601

U.S.A.

www.boschsecurity.com

© Bosch Security Systems, Inc., 2011